

T7 series

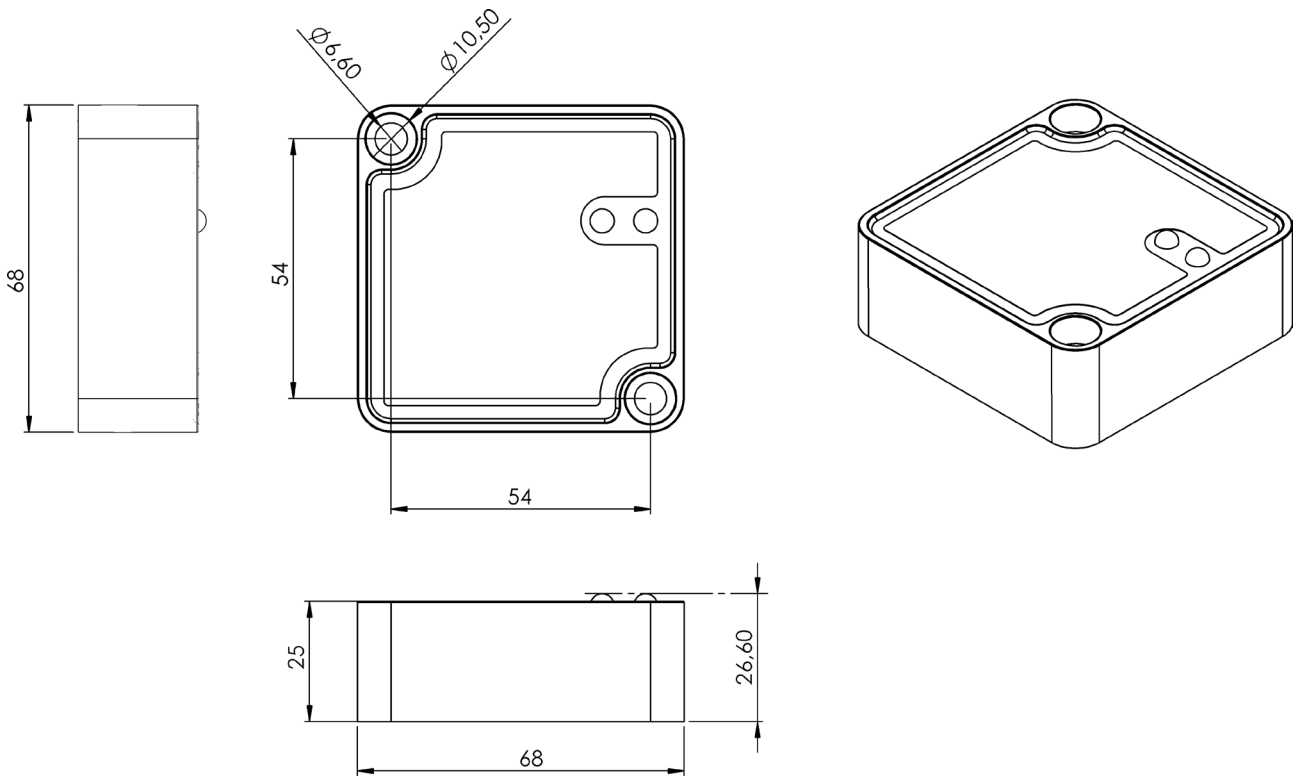

Mechanical specifications

All measurements in millimetres (mm)



With attached magnet

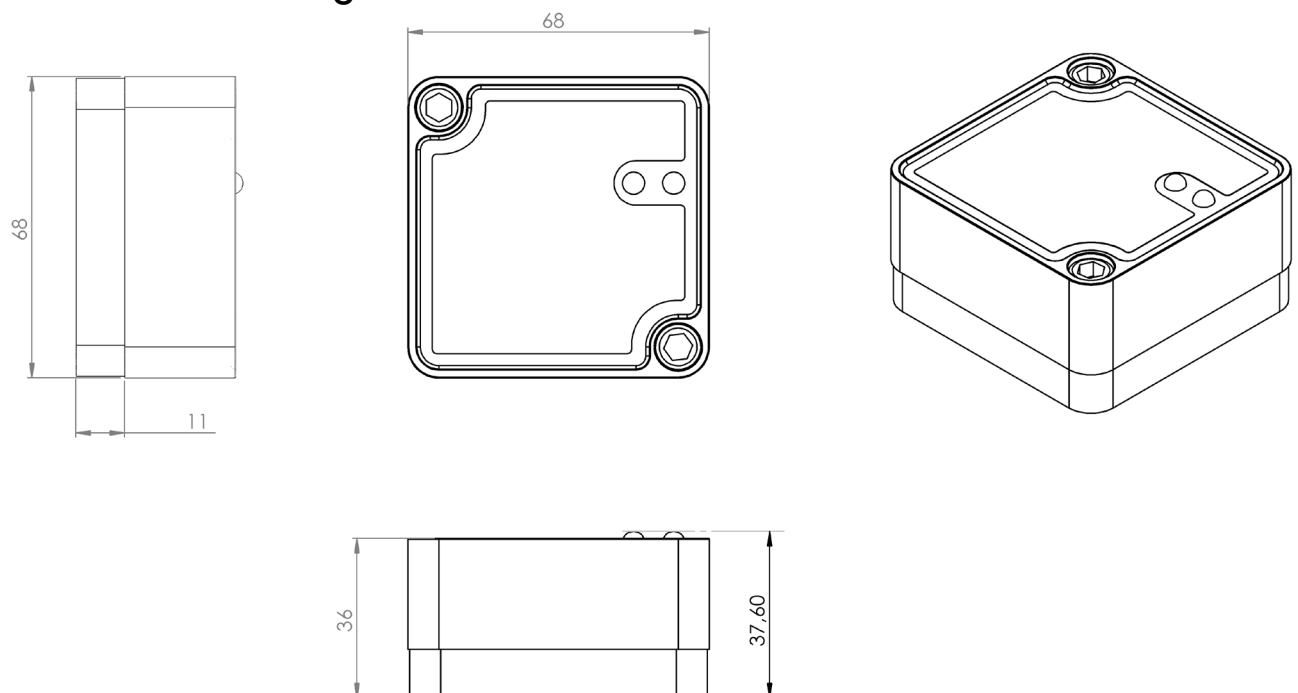

T7 series



Accessories

Sold separately

Mounting kit

Screws

Stainless, M6x25 mm, unbraco

Bushings

6,5 x 0,2 x 20,5 mm

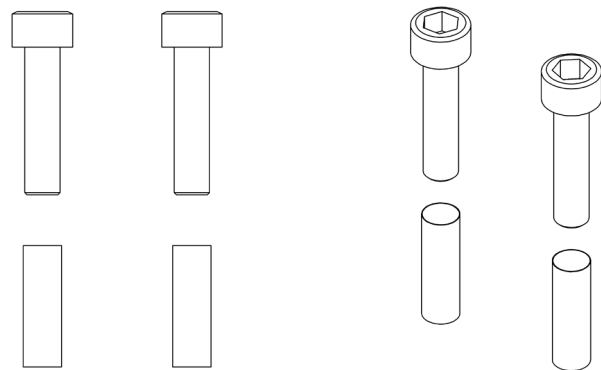

Magnet kit

Dimensions

68 mm x 68 mm x 11 mm

Weight

311 gram

Magnet strength

200N

Maximum torque moment

3 Nm

(Magnet kit includes screws and bushings).

